

Shelly® dimmer

Smart WiFi LED Dimmer USER GUIDE

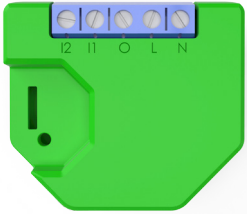

LEGEND:

- I2** - Switch input 2 for on/off/dimming
- I1** - Switch input 1 for on/off/dimming
- O** - Output
- L** - Line input (110-240V)
- N** - Neutral input (Zero)

The Shelly® smart WiFi dimmer by Allterco Robotics is intended to be installed directly to your lights in order to control and dim the light. It is intended to be mounted into a standard in-wall console, behind the light switches or other places with limited space. Shelly may work as a standalone device or as an accessory to a home automation controller.

SHELLY DIMMER CANNOT BE CONNECTED AND OPERATE A FAN. DOING SO MAY CAUSE DAMAGE TO THE UNIT OR FAN, INCLUDING CAUSING A FIRE!!!

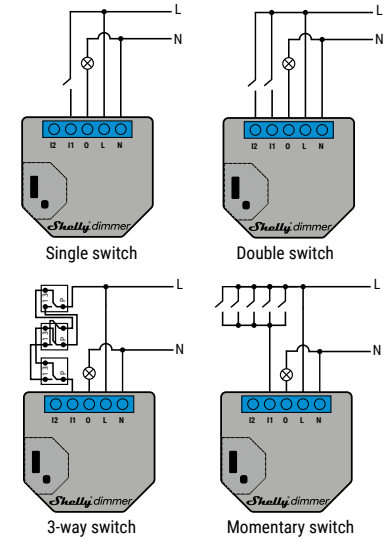

Specification

Power supply: 110-240V ±10% 50/60Hz AC	Working temperature: from 0°C to 35°C	Dimensions (HxWxL): 42 x 36 x 14 mm
Operational current: 0.25-1.7A	Radio signal power: 1mW	Electrical consumption: < 1,5 W
Device temperature protection: 105°C	Radio protocol: WiFi 802.11 b/g/n	Supported light types: * Incandescent and * Halogen light sources: 1-220W * Dimmable LED : 50-200VA / 1W - 200W
Complies with EU standards: • RE Directive 2014/53/EU • LVD 2014/35/EU • EMC 2004/108/WE • RoHS2 2011/65/EU	Frequency: 2400 - 2500 MHz	Resistive-inductive loads ferromagnetic transformers: 50-150VA
	Operational range (depending on local construction): • up to 50 m outdoors • up to 30 m indoors	

Introduction to Shelly®

Shelly® is a family of innovative Devices, which allow remote control of electric appliances through mobile phone, PC or home automation system. Shelly® uses WiFi to connect to the devices controlling it. They can be in the same WiFi network or they can use remote access (through the Internet). Shelly® may work standalone, without being managed by a home automation controller, in the local WiFi network, as well as through a cloud service, from everywhere the User has Internet access. Shelly® has an integrated web server, through which the User may adjust, control and monitor the Device. Shelly® has two WiFi modes - access Point (AP) and Client mode (CM). To operate in Client Mode, a WiFi router must be located within the range of the Device. Shelly® devices can communicate directly with other WiFi devices through HTTP protocol. An API can be provided by the Manufacturer. Shelly® devices

may be available for monitor and control even if the User is outside the range of the local WiFi network, as long as the WiFi router is connected to the Internet. The cloud function could be used, which is activated through the web server of the Device or through the settings in the Shelly Cloud mobile application.

The User can register and access Shelly Cloud, using either Android or iOS mobile applications, or any internet browser and the web site: <https://my.Shelly.cloud/>.

Technical Information

- Control through WiFi from a mobile phone, PC, automation system or any other Device supporting HTTP and/or UDP protocol.
- Microprocessor management.
- Shelly may be controlled by an external button/switch.

CAUTION! Danger of electrocution. Mounting the Device to the power grid has to be performed with caution.

CAUTION! Do not allow children to play with the button/switch connected to the Device. Keep the Devices for remote control of Shelly (mobile phones, tablets, PCs) away from children.

Installation Instructions

CAUTION! Danger of electrocution. The mounting/installation of the Device should be done by a qualified person (electrician).

CAUTION! Do not connect the Device to appliances exceeding the given max load!

CAUTION! Connect the Device only in the way shown in these instructions. Any other method could cause damage and/or injury.

CAUTION! Before beginning the installation please read the accompanying documentation carefully and completely. Failure to follow recommended procedures could lead to malfunction, danger to your life or violation of the law. Allterco Robotics is not responsible for any loss or damage in case of incorrect installation or operation of this Device.

CAUTION! Use the Device only with power grid and appliances which comply with all applicable regulations, short circuit in the power grid or any appliance connected to the Device may damage the Device.

RECOMMENDATION: The Device may be connected to and may control electric circuits and appliances only if they comply with the respective standards and safety norms.

RECOMMENDATION: The Device may be connected to and may control electric circuits and light sockets only if they comply with the respective standards and safety norms.

AWARENESS: If the Device is not connected to the supported light types, the dimming functionality may not be present. However, you will still be able to turn on and off your lights.

Initial Inclusion

Before installing/mounting the Device ensure that the grid is powered off (turned down breakers).

Connect the Shelly to the power grid following the wiring scheme above (fig.1). You may choose if you want to use Shelly with the Shelly Cloud mobile application and Shelly Cloud service. You can also familiarize yourself with the instructions for Management and Control through the embedded Web interface.

Control your home with your voice

All Shelly devices are compatible with Amazon Echo and Google Home.

Please see our step-by-step guide on:

- <https://shelly.cloud/compatibility/Alexa>
- <https://shelly.cloud/compatibility/Assistant>



MOBILE APPLICATION FOR MANAGEMENT OF SHELLY®



Shelly Cloud gives you opportunity to control and adjust all Shelly® Devices from anywhere in the world.

You only need an internet connection and our mobile application, installed on your smartphone or tablet.

To install the application please visit Google Play (Android - fig. 2) or App Store (iOS - fig. 3) and install the Shelly Cloud app.



fig. 2

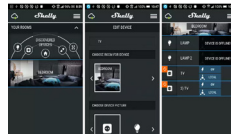

fig. 3

Registration

The first time you load the Shelly Cloud mobile app, you have to create an account which can manage all your Shelly® devices.

Forgotten Password

In case you forget or lose your password, just enter the e-mail address you have used in your registration. You will then receive instructions to change your password.

WARNING! Be careful when you type your e-mail address during the registration, as it will be used in case you forget your password.

After registering, create your first room (or rooms), where you are going to add and use your Shelly devices.

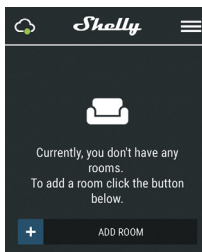

Shelly Cloud gives you opportunity to create scenes for automatic turning on or off of the Devices at predefined hours or based on other parameters like temperature, humidity, light etc. (with available sensor in Shelly Cloud).

Shelly Cloud allows easy control and monitoring using a mobile phone, tablet or PC.

Device Inclusion

To add a new Shelly device, install it to the power grid following the Installation Instructions included with the Device.

Step 1

After the installation of Shelly and the power is turned on, Shelly will create its own WiFi Access Point (AP).

WARNING: In case the Device has not created its own WiFi network with SSID like **shellydimmer-35FA58** check if you have connected Shelly correctly by the wiring schemes. If you do not see an active WiFi network with SSID like **shellydimmer-35FA58**, reset the Device. If the Device has been powered on, you have to power it off and on again. After turning the power on, you have 60 seconds to press 5 consecutive times either switch connected I1/I2. Or if you have physical access to the Device, press and hold the reset button for 10 seconds. When the LED indicator starts to flash quickly, release the button. Shelly should return to AP Mode. If not, please repeat or contact our customer support at: support@Shelly.cloud

Step 2

Choose "Add Device".

In order to add more Devices later, use the app menu at the top right corner of the main screen and click "Add Device". Type the name (SSID) and password for the WiFi network, to which you want to add the Device.

Step 3

If using iOS: you will see the following screen:

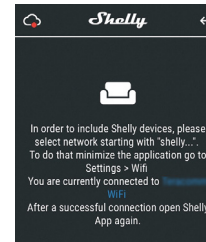

Press the home button of your iPhone/iPad/iPod. Open Settings > WiFi and connect to the WiFi network created by Shelly, e.g. **shellydimmer-35FA58**.

If using Android: your phone/tablet will automatically scan and include all new Shelly devices in the WiFi network that you are connected to.



Upon successful Device Inclusion to the WiFi network you will see the following pop-up:

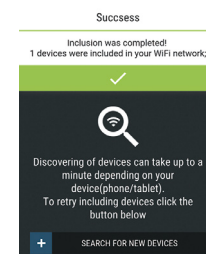

Step 4:

Approximately 30 seconds after discovery of any new Devices on the local WiFi network, a list will be displayed by default in the "Discovered Devices" room.



Step 5:

Enter Discovered Devices and choose the Device you want to include in your account.



Step 6:

Enter a name for the Device (in the Device Name field). Choose a Room, in which the Device has to be positioned. You can choose an icon or add a picture to make it easier to recognize. Press "Save Device".

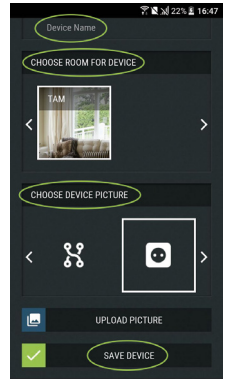

Step 7:

To enable connection to the Shelly Cloud service for remote control and monitoring of the Device, press "YES" on the following pop-up.

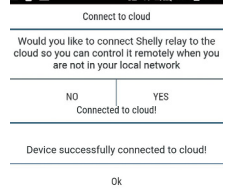

Shelly Devices Settings

After your Shelly device is included in the app, you can control it, change its settings and automate the way it works. To switch the Device on and off, use the Power button. To enter at the details menu of the Device, click on its name. From the details menu you may control the Device, as well as edit its appearance and settings.

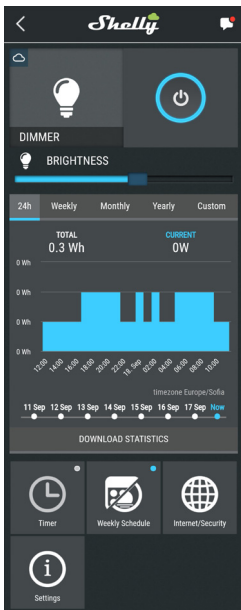

Timer

To manage the power supply automatically, you may use:
Auto OFF: After turning on, the power supply will automatically shutdown after a predefined time (in seconds). A value of 0 will cancel the automatic shutdown.
Auto ON: After turning off, the power supply will be automatically turned on after a predefined time (in seconds). A value of 0 will cancel the automatic power-on.

Weekly Schedule

Warning: This function requires an Internet connection. To use Internet, your Shelly has to be connected to a local WiFi network with an active internet connection. Shelly may turn on/off automatically at a predefined time, at sunrise/sunset, or at a specified time before or after sunrise/sunset. Multiple schedules are possible.

Internet/Security

WiFi Mode - Client: Allows the device to connect to an available WiFi network. After typing the details in the respective fields, press **Connect**.
WiFi Client Backup: Add a backup WiFi network, in case your primary one becomes unavailable.
WiFi Mode - Access Point: Configure Shelly to create a Wi-Fi Access point. After typing the details in the respective fields, press **Create Access Point**.
Cloud: Enable or Disable connection to the Cloud service.
Restrict Login: Restrict the web interface of Shelly with a Username and Password. After typing the details in the fields, press **Restrict Shelly**.

Settings

Power On Default Mode
This sets the default output state when Shelly is powered.
ON: Configure Shelly to turn ON, when it has power.
OFF: Configure Shelly to turn OFF, when it has power.
Restore Last Mode: Configure Shelly to return to last state it was in, when it has power.
Firmware Update
Update the firmware of Shelly, when a new version is released.
Button Type
• **One Button mode:** the device is controlled with a single switch.
• **Dual button mode:** the device is controlled dual switch.
• **Toggle switch one button:** the device is controlled by a single toggle switch.
• **Edge switch:** the device is controlled with an edge on/off.

Calibration
Shelly Dimmer needs calibration based on the type of light that you are going to use it with. To make a calibration, press **Start Calibration**.
Transition Time
Set the time (in milliseconds), for which Shelly Dimmer goes from 0% to 100%. The value can be from 0 to 5000 ms.
Night Mode
With this mode you can set a period of time and level of brightness, in which any turning on will set the brightness to the predefined level.

Time Zone and Geo-location
Enable or Disable the automatic detection of Time Zone and Geo-location.
Factory Reset
Return Shelly to its factory default settings.
Device Information
Here you can see the:
• **Device ID** - Unique ID of Shelly
• **Device IP** - The IP of Shelly in your Wi-Fi network

The Embedded Web Interface

Even without the mobile app, Shelly can be set and controlled through a browser and WiFi connection of a mobile phone, tablet or PC.

ABBREVIATIONS USED:

Shelly-ID – the unique name of the Device. It consists of 6 or more characters. It may include numbers and letters, for example **35FA58**.

SSID – the name of the WiFi network, created by the Device, for example **shellydimmer-35FA58**.

Access Point (AP) – the mode in which the Device creates its own WiFi connection point with the respective name (SSID).

Client Mode (CM) – the mode in which the Device is connected to another WiFi network.

Initial inclusion

Step 1

Connect Shelly to the power grid following the wiring schemes. Shelly will create its own WiFi network (AP).

Warning: In case the Device has not created its own WiFi network with SSID like **shellydimmer-35FA58** check if you have connected Shelly correctly by the wiring schemes. If you do not see an active WiFi network with SSID like **shellydimmer-35FA58**, reset the Device. If the Device has been powered on, you have to power it off and on again. After turning the power on, you have to power it off and on again. After turning the power on, you have 60 seconds to press 5 consecutive times either switch connected I1/I2. Or if you have physical access to the Device, press and hold the reset button for 10 seconds. When the LED indicator starts to flash quickly, release the button. Shelly should return to AP Mode. If not, please repeat or contact our customer support at support@shelly.cloud

Step 2

When Shelly has created an own WiFi network (own AP), with name (SSID) such as **shellydimmer-35FA58**. Connect to it with your phone, tablet or PC.

Step 3

Type **192.168.33.1** into the address field of your browser to load the web interface of Shelly.

Home Page

This is the home page of the embedded web interface. If it has been set up is correctly, you will see information about:

- Current power consumption, in Watts
- Current state (on/off)
- Current brightness level
- Power button
- Connection to Cloud
- Present time
- Settings

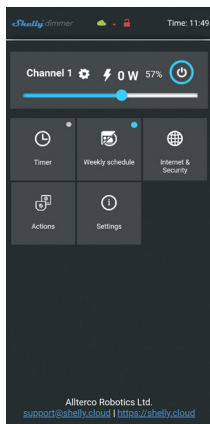

Timer

To manage the power supply automatically, you may use:
Auto OFF: After turning on, the power supply will automatically shutdown after a predefined time (in seconds). A value of 0 will cancel the automatic shutdown.
Auto ON: After turning off, the power supply will be automatically turned on after a predefined time (in seconds). A value of 0 will cancel the automatic power-on.

Weekly Schedule

Warning: This function requires an Internet connection.

To use Internet, a Shelly Device has to be connected to a local WiFi network with working internet connection. Shelly may turn on/off automatically at a predefined time, at sunrise/sunset, or at a specified time before or after sunrise/sunset. Multiple schedules are possible.

Internet/Security

WiFi Mode - Client: Allows the device to connect to an available WiFi network. After typing the details in the fields, press **Connect**.

WiFi Client Backup: Add a backup WiFi network, in case your primary one becomes unavailable.

WiFi Mode - Access Point: Configure Shelly to create a Wi-Fi Access point. After typing the details in the fields, press **Create Access Point**.

Cloud: Enable or Disable connection to the Cloud service.

Restrict Login: Restrict the web interface of Shelly with a Username and Password. After typing the details in the fields, press **Restrict Shelly**.

SNTP Server: You can set a custom SNTP Server. Type the URL address and press **Save**.

Warning: If you have entered incorrect information (wrong settings, usernames, passwords etc.), you will not be able to connect to Shelly and you have to reset the Device.

Warning: In case the Device has not created its own WiFi network with SSID like **shellydimmer-35FA58** check if you have connected Shelly correctly by the wiring schemes. If you do not see an active WiFi network with SSID like **shellydimmer-35FA58**, reset the Device. If the Device has been powered on, you have to power it off and on again. After turning the power on, you have 60 seconds to press 5 consecutive times either switch connected I1/I2. Or if you have physical access to the Device, press and hold the reset button for 10 seconds. When the LED indicator starts to flash quickly, release the button. Shelly should return to AP Mode. If not, please repeat or contact our customer support at support@shelly.cloud

Advanced - Developer Settings: Here you can change the action execution:

- Via CoAP (CoIoT)
- Via MQTT

Firmware Upgrade: Shows present firmware version. If a newer version is available, officially announced and published by the Manufacturer, you can update your Shelly Device. Click **Upload** to install it to your Shelly Device.

Settings

Power On Default Mode

This sets the default output state when Shelly is powered.

ON: Configure Shelly to turn ON, when it has power.

OFF: Configure Shelly to turn OFF, when it has power.

Restore Last Mode: Configure Shelly to return to last state it was in, when it has power.

SWITCH: Configure Shelly to operate accordingly to the state of the switch (button).

Time Zone and Geo-location

Enable or Disable the automatic detection of Time Zone and Geo-location.

Firmware Update: Update the firmware of Shelly, when a new version is released.

Button Type

- **One Button mode:** the device is controlled with a single switch.
- **Dual button mode:** the device is controlled dual switch.
- **Toggle switch one button:** the device is controlled by a single toggle switch.
- **Edge switch:** the device is controlled with an edge on/off.

Calibration

Shelly Dimmer needs calibration based on the type of light that you are going to use it with. To make a calibration, press **Start Calibration**.

Transition Time

Set the time (in milliseconds), for which Shelly Dimmer goes from 0% to 100%. The value can be from 0 to 5000 ms.

Night Mode

With this mode you can set a period of time and level of brightness, in which any turning on will set the brightness to the predefined level.

Factory Reset: Return Shelly to its factory default settings.

Device Reboot: Reboots the device.

Device Information

Here you can see the unique ID of Shelly.

Additional Features

Shelly allows control via HTTP from any other device, home automation controller, mobile app or server.

For more information about the REST control protocol, please visit: <https://shelly.cloud/developers/> or send a request to: developers@shelly.cloud

Environmental Protection



This marking on the device, accessories, or documentation indicates that the device and its electronic accessories must be disposed only in specially designated locations.



This marking on the battery, the instruction manual, the safety instructions, the warranty card or the packaging indicates that the battery in the device must be disposed only in specially designated locations.

Please follow the instructions for environmental protection and proper disposal of the Device, its accessories, and its packaging for the recycling of the materials for their further usage and to keep the environment clean!

Warranty Terms

1. The Device's warranty term is 24 (twenty four) months, beginning since the date of purchase by the End User. The Manufacturer does not be responsible for extra warranty terms by the End Seller.
2. The Warranty is valid for the territory of EU. The warranty is applicable in compliance with all relevant laws and users' rights protections. The purchaser of the Device is entitled to exercise his/her rights in accordance with all applicable laws and regulations.
3. Warranty terms are provided by Allterco Robotics EOOD (referred hereinafter as the Manufacturer), incorporated under the Bulgarian law, with address of registration 109 Bulgaria Blvd, floor 8, Triaditsa Region, Sofia 1404, Bulgaria, registered with the Commercial Register kept by the Bulgarian Ministry of Justice's Registry Agency under Unified Identity Code (UIC) 202320104.
4. Claims regarding the Conformity of the Device with the terms of the contract of sale shall be addressed to the Seller, in accordance with its terms of sale.
5. Damages such as death or body injury, deterioration or damages to objects different from the defective product, caused by a defective product, are to be claimed against the Manufacturer using the contact data of the Manufacturer's company.
6. The User may contact the Manufacturer at support@shelly.cloud for operational problems that may be resolved remotely. It is recommended that the User contact the Manufacturer before sending it for servicing.
7. The terms of removing defects depends on the commercial terms of the Seller. The Manufacturer is not responsible for ultimately servicing of the Device or for faulty repairs carried out by unauthorized service.
8. When exercising their rights under this warranty, the User must provide the Device with the following documents: receipt and valid warranty card with date of purchase.
9. After a warranty repair has been carried out, the warranty period is extended only for that period.
10. The warranty does NOT cover any damages to the Device which occur in the following circumstances:
 - When the Device has been used or wired inappropriately, including inappropriate fuses, overpassing maximal values of load and current, electric shock, short circuit or other problems in the power supply, the power grid or the radio network.
 - When there is a non-compliance between warranty card and/or without a purchase receipt, or attempted forgery of these documents, including (but not limited to) the warranty card or the documents proving the purchase.
 - When there has been a self-repair attempt, (de)installation, modification, or adaptation of the Device by unauthorized persons.
 - Intentional or negligent improper handling, storing or transportation of the Device, or in the event of non-observance of the instructions included in this warranty.
 - When a non-standard power supply, network, or faulty Devices have been used.
 - When damages occur which were caused regardless of the Manufacturer, including but not limited to: floods, storms, fire, lightning, natural disasters, earthquakes, war, civil wars, other force majeure, unforeseen accidents, robbery, water damage, any damages made by ingress of liquids, weather conditions, solar heating, any damages made by intrusion of sand, humidity, high or low temperature, or air pollution.
 - When there are other reasons beyond manufacturing defect, including but not limited to: water damage, ingress of liquid into the Device, weather conditions, solar overheating, intrusion of sand, humidity, low or high temperature, air pollution.[1]
 - When there have been mechanical damages (forced opening, breaking, cracks, scratches or deformations) caused by a hit, fall, or from another object, wrong use, or caused by not following the instructions for use.

• When damage has been caused by the use of faulty Devices and/or accessories.

• When damage has been caused by faulty software, a computer virus or other harmful behaviour on the Internet, or by lack of software updates or incorrect updates by a method not provided by either the Manufacturer or by the Manufacturer's software.

11. The range of warranty repairs does not include periodical maintenance and inspections, particularly cleaning, adjustments, checks, bug fixes or program parameters and other activities that must be performed by the User (Buyer). The warranty does not cover wear of the Device, because such elements have a limited lifespan.

12. The Manufacturer is not responsible for any property damage caused by a defect in the Device. The Manufacturer is not liable for indirect damages (including but not limited to loss of profits, savings, lost profits, claims by third parties) in connection with any defect of the Device, nor for any property damage or personal injury arising out of or related to the use of the Device.

13. The Manufacturer is not responsible for damage caused by circumstances independent of the Manufacturer, including but not limited to: floods, storms, fire, lightning, natural disasters, earthquakes, war, civil unrest and other force majeure, unforeseen accidents, or theft.

You can find the latest version of the Shelly Dimmer user guide on this address: <https://shelly.cloud/support/user-manuals/> Or by scanning this QR code:

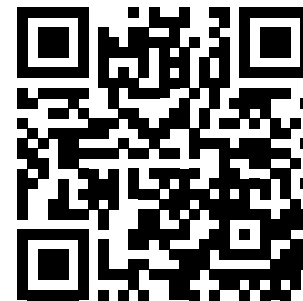

Manufacturer: Allterco Robotics EOOD
Address: Sofia, 1407, 103 Cherni vrab Blvd.
Tel.: +359 2 988 7435
E-mail: support@shelly.cloud
<http://www.Shelly.cloud>

The Declaration of Conformity is available at: <https://shelly.cloud/declaration-of-conformity/>

Changes in the contact data are published by the Manufacturer at the official website of the Device: <http://www.Shelly.cloud>

The User is obliged to stay informed for any amendments of these warranty terms before exercising his/her rights against the Manufacturer.

All rights to trademarks She® and Shelly®, and other intellectual rights associated with this Device belong to Allterco Robotics EOOD.

